

## Product Brochure

### MCSD Benchtop range (MCSD-100J, 200J, 500J and 800J)

The MCSD series of precision microprocessor-controlled capacitor discharge Magnet, Charger, Setter, Demagnetiser (MCSD) has been designed as a flexible magnet processor for the laboratory and as the production workhorse for calibrating (stabilising, setting or ageing) all types of permanent magnets. There are two form-factors the MCSD 100J and 200J in a Benchtop-mini size and a larger format Bench-top Midi MCSD-500J and 800J. The Hirst MCSD range was first introduced in the 1980s and is in service in 100s of locations round the world. This is the 3rd generation of MCSD, was first introduced in 2020.



### Key benefits

- **Powerful magnetiser and demagnetiser** – 100J to 800J with a maximum voltage of 1000V.
- **Magnet calibrator and setter** – high accuracy calibrator and setter with a 1 V resolution (0.1%).
- **Compact size** – benchtop form factor for use with external coil fixtures via fast swap connectors.
- **Reliable** – Used in over 100 production lines (several hundred units sold) around the world since the 1980s.
- **Easy-to-use** - with 4 modes CHARGE, SET, CAL and DEMAG with voltage display with indicators to show user defined settings and robust buttons for simple operation.
- **High reliability process buttons** – main action buttons (Pulse, Abort, Step x3, Clear) capable of 1million + operations ideal for production environments.
- **Single fast swap connector** – to allow multiple fixtures to be used.
- **Reverse polarity** – ability to magnetise in either direction at press of a button.
- **Magnetising fixtures** – Standard Hirst magnetising fixtures J2A range can be used with adjustable and customisable pole pieces or custom fixtures can be designed by Hirst.
- **Communications** - A range of industry standard connectors two RS232 ports with SCPI and CANopen interfaces for connection to Hirst gaussmeters and fluxmeters and PCs / Computers and automation systems.
- **Safety** – Interlock control, internal protection circuits prevent damage.

### Applications

- Designed for both factory floor and laboratory use across a range of applications.
- Magnetisation to saturation for all types of magnetic assemblies and magnetic materials.
- Aerospace Sensors – magnetic calibration of sensors critical aircraft sensors, backup compasses, cockpit oxygen sensors.
- Audio – small loudspeakers .
- Reed relay manufacture.
- Small electric motors, valves and actuators.

### The MCSD system

Hirst's range of MCSD systems (Magnetiser Calibrator Setter Demagnetiser) are designed for the knockback, setting, calibrating, and treating of permanent magnets. These units offer functions that are known by various names including Magnet Treaters, Magnet Setters, Magnet Agers, Magnet Calibrators The most common application for the MCSD range is for sensor manufacture. These are benchtop units that can be connected to other equipment or even a PC to calibrate

magnets to specific levels. It is also possible to manually calibrate the magnets using the easy-to-use buttons on the front panel.

## Why calibrate a magnet?

There may be several reasons for calibrating a magnet, the most common are

- Knock back for stability
- Calibration to a specific level

Certain grades of magnets, particularly AlNiCo magnets will exhibit an unwanted behaviour after magnetising. After fully magnetising the magnet, the magnet will slowly lose some of its magnetisation over time. To mitigate this effect, it is often necessary to knock back, or artificially age the magnet to put it into a stable state where it will no longer lose magnetisation. Terms for this including knock back, setting, calibrating or treating magnets.

Calibration for a specific level is another requirement. If the magnet is to be used in a sensor, or a moving coil meter, light aircraft compass or several other applications then its exact magnetisation level may be important. In this case the magnet is also knocked back until it achieves a desired level that is determined via external feedback such as a gaussmeter or fluxmeter.

## Technical Data

Modes	Flexible magnetiser and demagnetiser with 4 modes of operation:- CHARGE, SET, CAL (Calibration) and DEMAG
Maximum voltage	Up to 1000V
Magnetiser Energy	100J, 200J, 500J and 800J versions
High Voltage resolution	1V (0.1%)
Coil connections	Fast swap connector – 30 second switch over
Number of fixtures that can be connected	Single
Output Configurations	Magnetiser plus ability to magnetise in either direction at press of a button with automatic polarity inversion for de-magnetisation
Communications and interfaces	Serial connection - 2x RS232 9 way 'D' inc SCPI and 1x 9 way 'D' CAN bus (CANopen)
Integration	Easy integration with Hirst GM08 gaussmeters, IFM06 fluxmeter and PCs for custom application development
Display	4-digit Voltage display with 10 intuitive input buttons with LED indicators
Colours and materials	Steel and Aluminium case – oil and puncture resistant front panel
Dimensions / Weight	Benchtop-mini 270 x 530 x 443mm approx. / 25 kg Benchtop-midi 442 x 530 x 347 mm approx. / 35kg
Operating Temperature Range	+5° C to +40° C
Power Supply	220VAC 50-60Hz 13A or 110VAC option + Ground. Max 3m cable length

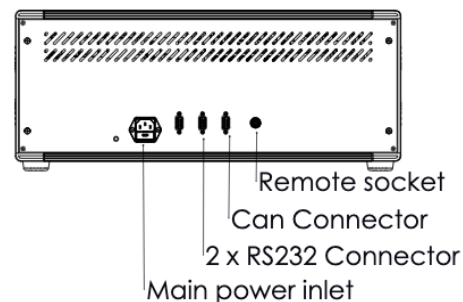
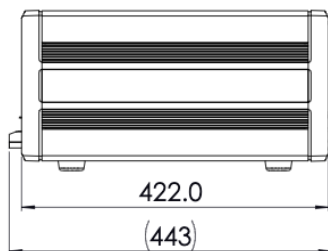
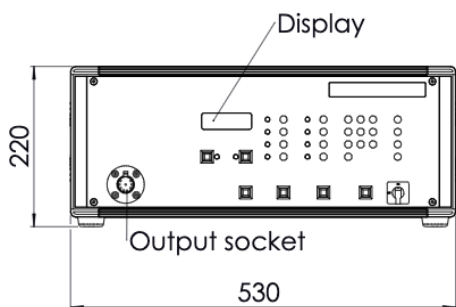

MCSD-100J and 200J

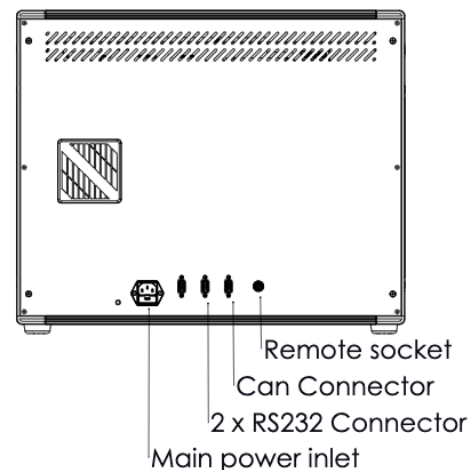
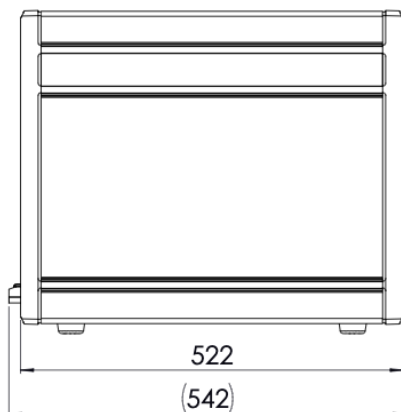
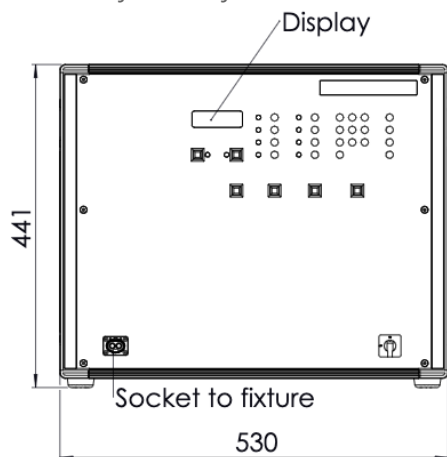

MCSD-500J and 800J

## Warranty and Calibration

Supplied calibrated with 1 year warranty. A calibration is required every year to maintain the highest levels of performance – Hirst has a dedicated team of installation and service engineers, available to travel worldwide to install and support equipment, service contracts are available. See website for details.

## Accessories and Application examples

### Standard Hirst Magnetiser fixtures

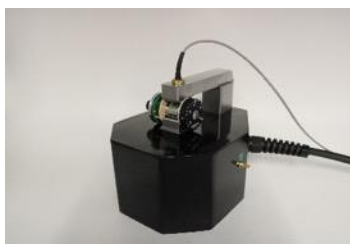

Above standard Hirst JA2, 2 pole axial fixture up to 500J for sensor and other applications showing custom pole pieces examples

## Product Application Examples



MCSD200J magnetiser and custom fixture and 2 gaussmeter probes with GM08s used for precision navigation sensor production.



MCSD-100J Magnetiser with custom fixture for production of critical aircraft sensors with IFM06 Fluxmeter control in a production rack



Hirst Magnetic Instruments has been active in providing solutions for 60 years in magnetics and magnetic measurement. Hirst manufactures precision hand-held gaussmeters, Fluxmeters, de-magnetisers, bench top & workstation industrial magnetisers, industrial production-line magnetisers, pulse field magnetometers (PFMs) for developing characterising magnetic materials and many custom projects.

Hirst Magnetic Instruments Ltd reserves the right to make changes to any specifications or performance implied in this product brochure without notice – please refer to [www.hirst-magnetics.com](http://www.hirst-magnetics.com) for the latest version.

MCSD product brochure v1.5 9.8.22